

Data Sheet



Article number: 20329280

Description: E+G Handwheel
GN 555-100-B10-A

Measures

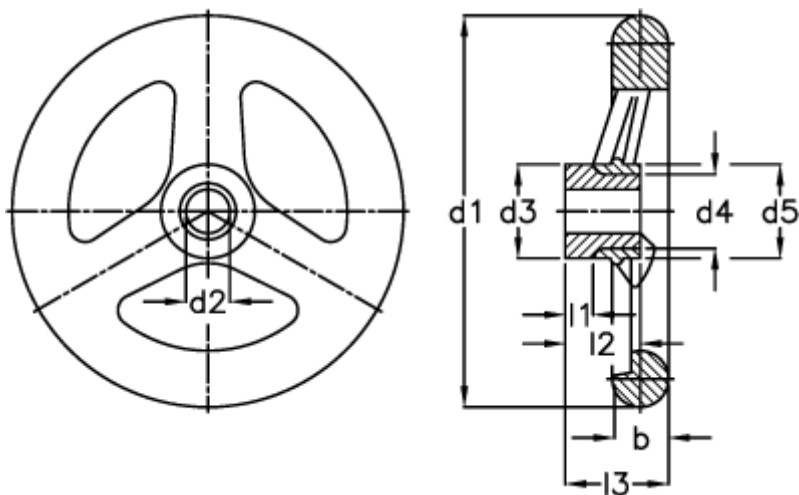

b	= 15	l2 -0.5	= 22
d1	= 100	l3	= 26
d2 H7	= 12	Number of spokes	= 3
d2 H7	= 10		
d3	= 24		
d4	= 18		
d5	= 28		
l1 -0.5	= -		